



CT INNOVATIONS  
- TOUGHMesh -

# The GOLD Standard

With over 100 years of combined electrical and mechanical support systems experience, the CT Innovations leadership team set out to build an agile company that is focused on, and dedicated to, customers, not shareholders. In our view, great service is not a luxury; it is a necessity that too few deliver.

At CT Innovations, we focus on one thing and one thing only our customers' needs. We believe in taking action, being easy to do business with, and being held accountable by those we serve. We are not all things to all people. We will, however, always strive to be our customers' preferred supplier in our space and to be recognized as an organization that consistently provides superior value, service, and innovation.

CT Innovations Company Creed:  
“Do Better. Be Better.”

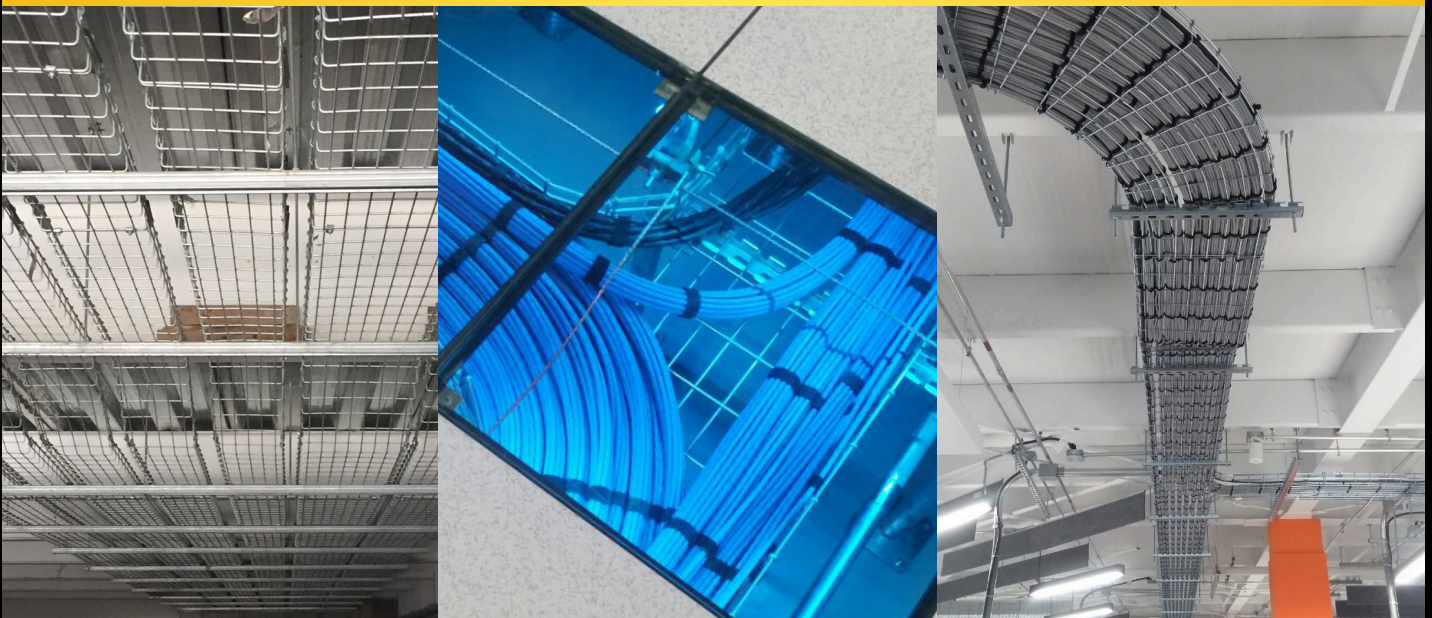

# TOUGHMesh System



## Straight Sections

*10ft long cable support system*

Wirebasket made up of lateral and longitudinal wires with a nominal 2x4in mesh pattern, designed for maximum cable support, field flexibility, strength, and safety.

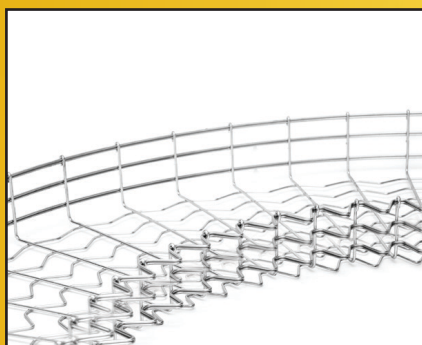

## Fittings

*Pre-made horizontal bends*

Manufactured from the same great strength and quality of our straight sections, Crimped-2-Go fittings save tremendous time and money over the conventional method of cutting securing, cutting securing...etc



## Covers

*Snap-On Covers*

Install covers with a SNAP! Utilizing the patented CurlSafe safety edge protection design, CT Innovations was able to engineer extremely quick Snap-On Covers to finish your job outright.



## Accessories

*Designed for simplifying installations*

Understanding that every jobsite brings different challenges, our team has spent hours designing user focused accessories engineered for easier, quicker, and safer installations.

# TOUGHMesh

## ENGINEERED PROFICIENCY

Performance you can see and feel. With a patented “Safe-T-Curl” designed to mitigate stress points along the edge of the basket, and an engineered wire portfolio designed for the ultimate strength to weight ratio, CT Innovations can reduce material and labor on your next project.

## EXCEPTIONAL VALUE

As the price of project materials continue to increase, it has never been more important to drive cost out of a project. CT Innovations has invested in fully automated wire weld machines allowing for improved manufacturing efficiency, improved flexibility, and improved quality.

## INNOVATIVE PROTECTION

Never satisfied with the status quo, CT Innovations has pushed the boundaries of what environmental protection means in the electrical and mechanical industries. With thousands of hours of testing, and over 100yrs of industry experience, CT Innovations has brought to market an all-in-one indoor/outdoor finish, TOUGHGalv, that is aesthetically pleasing, cost effective, and environmentally resistant up to 40yrs offshore.

## AVAILABILITY

CT Innovations carries an extensive amount of stock to ensure the market has product when they need it, not when it's convenient. No longer do you have to wait weeks for manufacturers to source material and work it into their schedule; buy with confidence with ready to ship inventory from CTI.



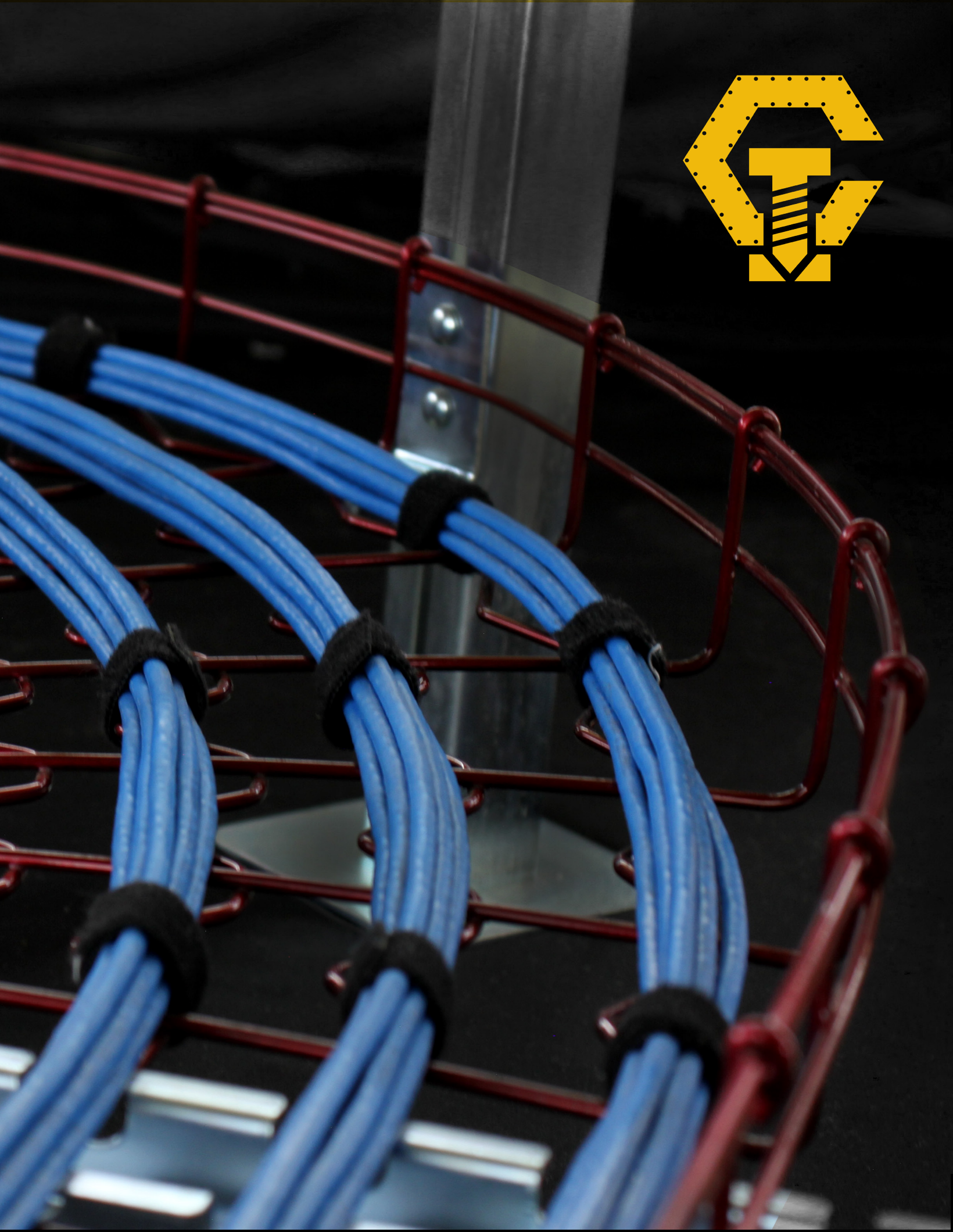

# TOUGHMesh Properties

## Grounding Information:

This product is classified by Underwriters Laboratories, Inc. as an equipment grounding conductor only. Grounding eligibility is determined by cross-sectional area, material properties, and splicing methodology; therefore smaller sizes may not apply, please reference chart on next page.

## Finish Information:

- PL:** Plain wire, no finish  
Recommened Application: Special fabrication  
ASTM A510/A510M
- EG:** Electroplated zinc galvanized finish applied after fabrication  
Recommened Application: Indoor  
ASTM B633
- PT:** Painted finish applied after fabrication  
Recommened Application: Indoor  
ASTM: N/A
- TG:** TOUGHGalv finish applied before fabrication  
Recommened Application: Indoor / outdoor / industrial / offshore  
ASTM B997
- S6:** Stainless steel 316 finish applied before fabrication  
Recommened Application: Indoor / outdoor / industrial / offshore  
ASTM: A580/A580M

## Protection Information:

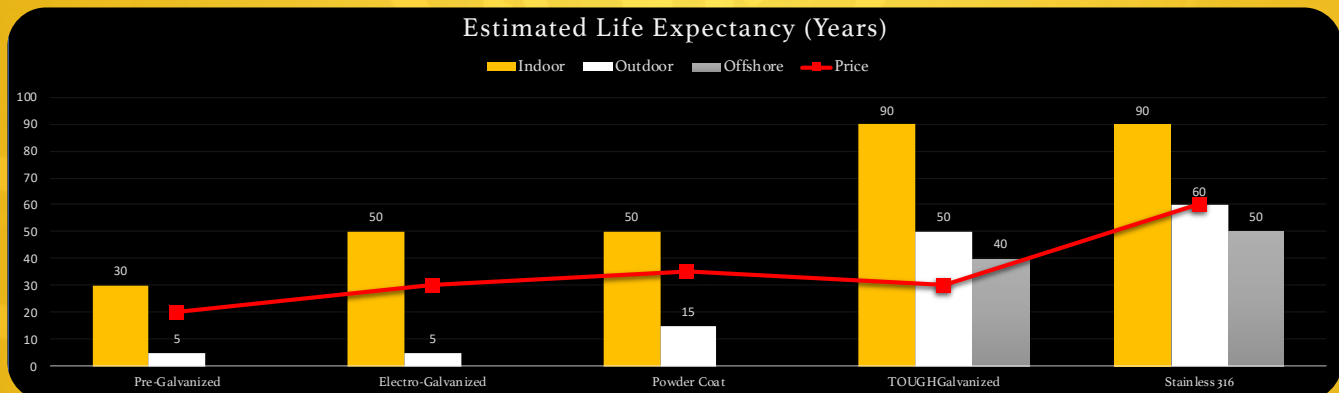

# Straight Sections



**Height: 2"**

**h** Inside Height: 2.1in **H** Outside Height: 2.5in



**Height: 4"**

**h** Inside Height: 4.1in **H** Outside Height: 4.5in



**Height: 6"**

**h** Inside Height: 6.0in **H** Outside Height: 6.2in

## TMS-4X12X10-TG

Product Series & Type

TMS = TOUGHMesh Straight

Height

2 = 2"  
4 = 4"  
6 = 6"

Inside Width

02 = 2" 12 = 12"  
04 = 4" 16 = 16"  
06 = 6" 18 = 18"  
08 = 8" 20 = 20"  
10 = 10" 24 = 24"

Length

10 = 10'

Finish

PL TG  
EG S6  
PT

\*Please contact CTI for non-listed sizes available

Basket Size H X W	Load (lbs/ft) 5ft	Reccomended Splices			Est. Cable Fill QTY (50% fill)		Nominal Area (in <sup>2</sup> ) Inside Basket	Physical Weight (lbs) 10ft sections
		Washer Splice Kits	Posi-Lok Mini	Posi-Lok	CAT 6 (.25in)	CAT 6A (.28in)		
2X2	15	2			40	32	4	4.5
2X4	18	2	2		81	64	8	6.7
2X6	24	2	2		122	97	12	7.5
2X8	31	3	2		163	129	16	8.7
2X10	46	3	2		203	162	20	10.6
2X12	55	3		2	244	194	24	12.8
2X16	117	4		2	326	259	32	19.3
2X18	117	4		2	366	292	36	19.7
2X20	123	4		2	407	324	40	24.8
2X24	132	4		2	489	389	48	27.8
4X4	62	4	2		163	129	16	8.7
4X6	66	4	2		244	194	24	10.5
4X8	78	5	2		326	259	32	12.8
4X10	78	5	2		407	324	40	18.4
4X12	108	6		2	489	389	48	19.3
4X16	123	6		2	652	519	64	24.8
4X18	127	6		2	733	584	72	25.7
4X20	137	7		2	815	649	80	27.8
4X24	145	7		2	978	779	96	28.4
6X8	62	6	2		489	389	48	19.3
6X10	62	6	2		611	487	60	23.8
6X12	117	7		2	733	584	72	24.8
6X16	133	7		2	978	779	96	27.8
6X18	144	7		2	1100	877	108	29.3
6X20	146	8		2	1222	974	120	30.9
6X24	148	8		2	1467	1169	144	35.2

# C2G Fittings



**Height: 2"**

<b>h</b> Inside Height: 2.1in	<b>Width (in)</b>	2	8	16
<b>H</b> Outside Height: 2.5in		4	10	20
<b>▲</b> Length: 10ft		6	12	

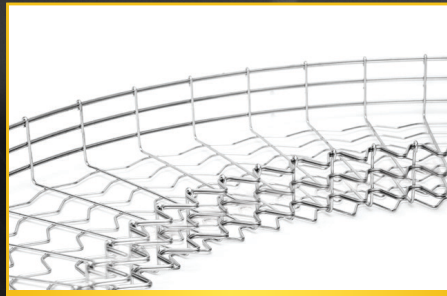

**Height: 4"**

<b>h</b> Inside Height: 4.1in	<b>Width (in)</b>	4	10	20
<b>H</b> Outside Height: 4.5in		6	12	
<b>▲</b> Length: 10ft		8	16	

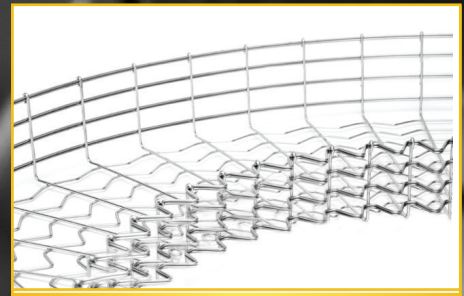

**Height: 6"**

<b>h</b> Inside Height: 6.0in	<b>Width (in)</b>	8	16	
<b>H</b> Outside Height: 6.2in		10	20	
<b>▲</b> Length: 10ft		12		

## TMF-4X12-90HB-TG

**Product Series & Type**  
TMF = TOUGHMesh Fitting

**Height**  
2 = 2"  
4 = 4"  
6 = 6"

**Inside Width**  
02 = 2"    12 = 12"  
04 = 4"    16 = 16"  
06 = 6"    18 = 18"  
08 = 8"    20 = 20"  
10 = 10"

**Angle**  
45 = 45  
90 = 90

**Style**  
HB = Horz Bend

**Finish**  
PL TG  
EG S6  
PT

\*Please contact CTI for special requests

### 90 HB Fabrication Time

■ C2G ■ 2in Tall ■ 4in Tall ■ 6in Tall

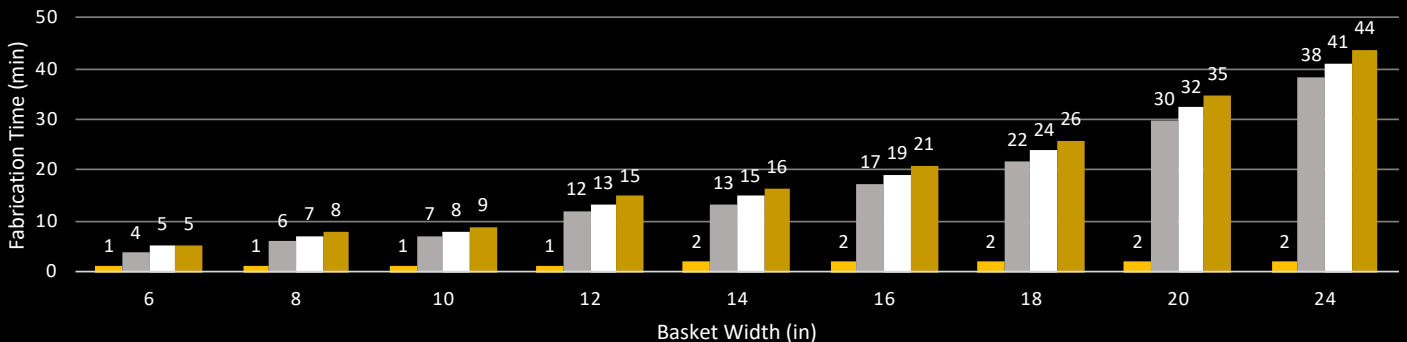

\*Times may vary based on experience and conditions



# Snap-On Covers



## Snap-On Covers

Covers do not require any additional accessories for its installation, it is placed under pressure on the upper curls of the tray.

### Width (in)

	2	8	16
	4	10	20
	6	12	24



## TMC-12X10-TG

**Product Series & Type**  
TMC = TOUGHMesh Cover

**Inside Width**  
02 = 2"    12 = 12"  
04 = 4"    16 = 16"  
06 = 6"    18 = 18"  
08 = 8"    20 = 20"  
10 = 10"   24 = 24"

**Length**  
10 = 10'

**Finish**  
EG  
PT  
S6

\*Please contact CTI for special requests  
\*\*For indoor use only

## Cover Installation Comparison

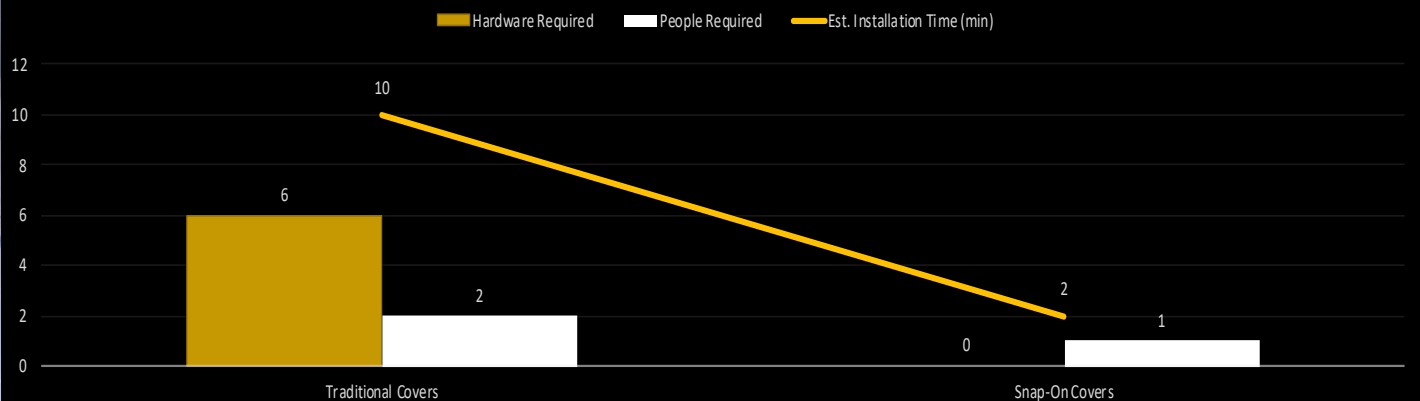

\*Times may vary based on experience and conditions

# Accessories

## POSI-LOK SPLICE PLATES

After installing and designing for years, our team knew there was a better means of connecting basket sections. Traditional 3 piece kits are strong but are very time consuming and quick connect splices are fast but lack rigidity. To solve these common issues, CT Innovations is happy to introduce the market to our POSI-LOK splice plate.

## RAPID-HANGERS

Whether your project calls for a single ATR drop or a more traditional trapeze kit, CT Innovations has engineered a support solution to dramatically increase installation efficiency by removing unnecessary hold down restraints and integrating a toolless clip-in unibody design.

## CORNER SUPPORT KITS

When cable support is essential, leaving space around intersecting unions such as horizontal tees or horizontal crosses is unacceptable. With CT Innovations corner kits, free hanging wires are a thing of the past. With a clip-in design, and a fully supported corner, install your sensitive cables with confidence and ease.

## MODULAR WALL SUPPORT SYSTEM

If trapeze supports are not within scope and a wall mount is required, look no further than CT Innovations Modular Wall Support System. Utilizing 10ft long vertical sticks that can be cut to fit and lateral risers that simply lock into place, this system is ideal for maximum repeatability.



“The quality you expect  
and the simple installation  
you deserve.”

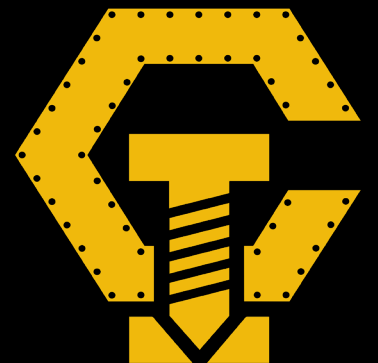

# Splices & Unions

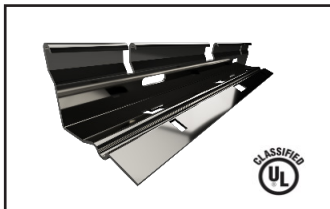

## Posi-Lok Splice

Sold in Pairs

**Use:** connect two baskets together  
**Box Qty:** 10 pieces  
**Compatibility:** W: 12"-24" H: All  
**Hardware:** N/A

TMA-PLOK-EG

TMA-PLOK-S6

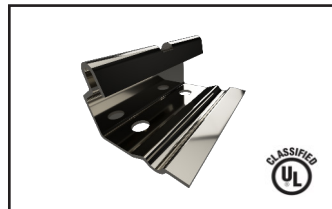

## Posi-Lok Mini Splice

Sold in Pairs

**Use:** connect two baskets together  
**Box Qty:** 20 pieces  
**Compatibility:** W: 2"-10" H: All  
**Hardware:** N/A

TMA-PLOKM-EG

TMA-PLOKM-S6



## Washer Splice Kit

Sold in Bags of 20

**Use:** connect baskets & form fittings  
**Box Qty:** 100 (5 bags of 20)  
**Compatibility:** W: 2"-24" H: All  
**Hardware:** 6mm

TMA-WSKIT-EG

TMA-WSKIT-S6



## Hold Down Kit

Sold In Bags of 20

**Use:** retain basket & accessories  
**Box Qty:** 100 (5 bags of 20)  
**Compatibility:** W: 2"-24" H: All  
**Hardware:** 6mm

TMA-HDKIT-EG

TMA-HDKIT-S6

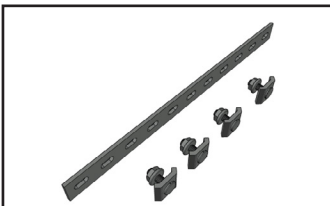

## Splice Bar Kit

Sold Individually

**Use:** connect baskets & form fittings  
**Box Qty:** 20 kits  
**Compatibility:** W: 2"-24" H: All  
**Hardware:** 6mm HDKIT

TMA-SBKIT-EG

TMA-SBKIT-S6



## Expansion Splice Kit

Sold In Pairs

**Use:** thermal expansion control  
**Box Qty:** 20 kits  
**Compatibility:** W: 2"-24" H: All  
**Hardware:** 6mm HDKIT

TMA-EXSB-EG

TMA-EXSB-S6

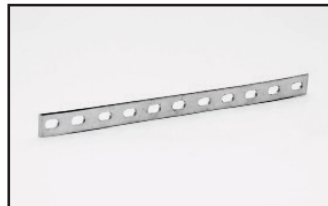

## Standard Splice Bar

Sold Individually

**Use:** 10.5" reinforcement bar  
**Box Qty:** 20 pieces  
**Compatibility:** W: 2"-24" H: All  
**Hardware:** Not Included (Ref: HDKIT)

TMA-STSB-EG

TMA-STSB-S6

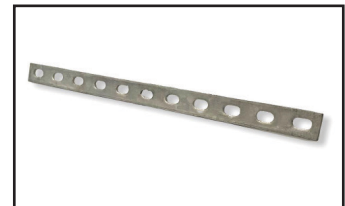

## HD Splice Bar

Sold Individually

**Use:** 40" HD reinforcement bar  
**Box Qty:** 20 pieces  
**Compatibility:** W: 2"-24" H: All  
**Hardware:** Not Included (Ref: HDKIT)

TMA-HDSB-EG

TMA-HDSB-S6



## Flat Cross Washer

Sold In Bags of 20

**Use:** form fittings & secure basket  
**Box Qty:** 100 (5 bags of 20)  
**Compatibility:** W: 2"-24" H: All  
**Hardware:** Not Included (Ref: HDKIT)

TMA-FLXW-EG

TMA-FLXW-S6



## Ground Bolt

Sold In Bags of 20

**Use:** secure separate ground wire  
**Box Qty:** 100 (5 bags of 20)  
**Compatibility:** W: 2"-24" H: All  
**Hardware:** N/A

TMA-GRND

NA

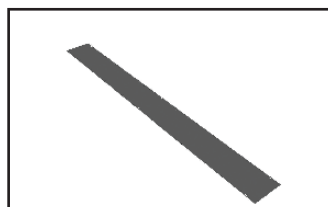

## Poly Liner Insert

Sold Individually

**Use:** 10ft .8mm cable protection  
**Box Qty:** 20 pieces  
**Compatibility:** W: 2"-24" H: All  
**Example pt/n:** TMA-PLYL-08

TMA-PLYI-##

NA



Coming 2023

## Corner Kit

Sold In Pairs

**Use:** HT & HX corner cable support  
**Box Qty:** 10 pieces  
**Compatibility:** W: All H: 02, 04, 06  
**Example pt/n:** TMA-CKIT-04-EG

TMA-CKIT-##-EG

NA

# Hangers & Brackets



**Rapid Hanger  
(Universal)**  
Sold Individually  
Use: 10ft universal basket support  
Box Qty: 20  
Compatibility: W: 4" - 24" H: All  
Hardware: Not Included (3/8")

TMA-URH-EG  
TMA-URH-S6



**HD Ceiling Bracket  
(Center Hung)**  
Sold Individually  
Use: ceiling mount for 3/8" ATR  
Box Qty: 10  
Compatibility: W: 2" - 24" H: All  
Hardware: Not Included (3/8")

TMA-HDCB-EG  
NA



**Suspension Clip  
(Universal)**  
Sold In Bags of 20  
Use: 1/4" ATR suspension support  
Box Qty: 10  
Compatibility: W: 2" - 12" H: All  
Hardware: Not Included (1/4")

TMA-USC-EG  
TMA-USC-S6



**Lay-In Cable Hanger**  
Sold Individually  
Use: clip in basket support  
Box Qty: 10  
Compatibility: W: 2" - 6" / H: 2"  
Hardware: Not Included (1/4")

TMA-LICH-EG  
TMA-LICH-S6



**4" Suspension Clip**  
Sold Individually  
Use: suspension or mounted support  
Box Qty: 10  
Compatibility: W: 4" H: All  
Hardware: Not Included (1/4")

TMA-4SC-EG  
TMA-4SC-S6



**2" Suspension Clip**  
Sold In Bags of 20  
Use: suspension or mounted support  
Box Qty: 100  
Compatibility: W: 2" H: All  
Hardware: Not Included (1/4")

TMA-2SC-EG  
TMA-2SC-S6



**L Bracket**  
Sold Individually  
Use: L shaped wall support  
Box Qty: 10  
Compatibility: W: 4"-24" H: All  
Example pt/n: TMA-LBRKT-04-EG

TMA-LBRKT-##-EG  
TMA-LBRKT-##-S6



**C Bracket**  
Sold Individually  
Use: C shaped wall support  
Box Qty: 10  
Compatibility: W: 4"-12" H: All  
Example pt/n: TMA-CBRKT-12-EG

TMA-CBRKT-##-EG  
TMA-CBRKT-##-S6



**Vertical Wall Support Bracket**  
Sold Individually  
Use: 10ft vertical mounting bracket  
Box Qty: 10  
Compatibility: W: 4"-24" H: All  
Hardware: Not Included (Ref: LRSB)

TMA-VWSB-EG  
TMA-VWSB-S6



**Lateral Riser Support Bracket**  
Sold Individually  
Use: lateral support bracket  
Box Qty: 10  
Compatibility: W: 4"-24" H: All  
Example pt/n: TMA-LRSB-12-EG

TMA-LRSB-##-EG  
TMA-LRSB-##-S6



**Adjustable Floor Stand**  
Sold Individually  
Use: 3"-14" adjustable floor stand  
Box Qty: 10  
Compatibility: W: 4"-24" H: All  
Example pt/n: TMA-AJFS-EG

TMA-AJFS-EG  
NA



**Strut Wall Bracket**  
Sold Individually  
Use: 16G HD wall support  
Box Qty: 10  
Compatibility: W: 4"-24" H: All  
Example pt/n: TMA-SWB-12-EG

TMA-SWB-##-EG  
TMA-SWB-##-S6

# Organization & Hardware



**Cable Barrier**

Sold Individually

Use: 10ft metallic cable organizer  
 Box Qty: 10 pieces  
 Compatibility: W: 4"-24" H: 02,04,06  
 Example pt/n: TMA-PLYL-02-EG

TMA-CBAR-##-EG

TMA-CBAR-##-S6

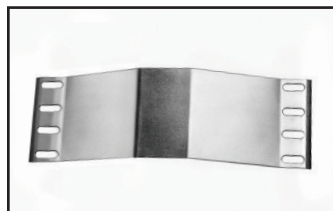

**Cable Bridge**

Sold Individually

Use: metallic fitting cable bridge  
 Box Qty: 10 pieces  
 Compatibility: W: 4"-24" H: All  
 Hardware: Not Included (HDKIT)

TMA-CBRG-EG

NA



**Cable Drop Out**

Sold Individually

Use: 4" waterfall for cable drops  
 Box Qty: 10 pieces  
 Compatibility: W: 4"-24" H: All  
 Example pt/n: TMA-CBLD-12-EG

TMA-CBLD-EG

TMA-CBLD-S6



**Accessory Mounting Clip**

Sold In Bags of 20

Use: snap on accessory mount  
 Box Qty: 100 (5 bags of 20)  
 Compatibility: W: 4"-24" H: All  
 Hardware: Not Included

TMA-AMC-EG

TMA-AMC-S6



**Strut Retention Clip**

Sold In Bags of 20

Use: clip to secure basket to strut  
 Box Qty: 100 (5 bags of 20)  
 Compatibility: W: 4"-24" H: All  
 Hardware: NA

TMA-SRC-EG

NA

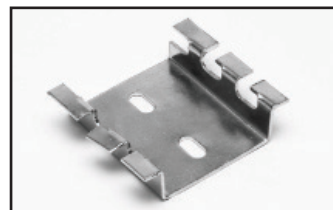

**Box Connector**

Sold In Bags of 20

Use: secure electrical box to basket  
 Box Qty: 40 (2 bags of 20)  
 Compatibility: W: 4"-24" H: 04", 06"  
 Hardware: NA

TMA-BXCN-EG

NA

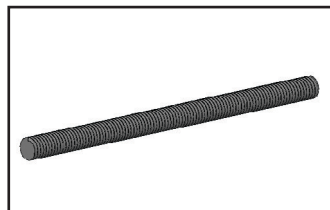

**All Thread Rod**

Sold Individually

Sizes: 1/4"(25), 3/8"(38), and 1/2"(50)  
 Box Qty: 10 pieces  
 Length: 10ft  
 Example pt/n: TA25ATR-GLV

TA##ATR-GLV

NA

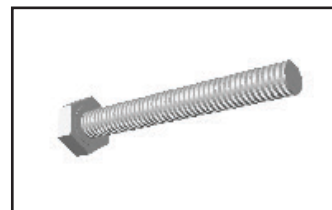

**Hex Head Cap Screw**

Sold In Bags of 20

Sizes: 1/4"(25), 3/8"(38), and 1/2"(50)  
 Box Qty: 100 (5 bags of 20)  
 Lengths: 1.25", 1.00"  
 Example pt/n: TA38HX125-GLV

TA##HX##-GLV

TA##HX##-S6

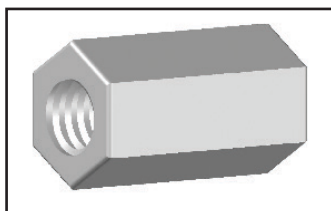

**ATR Coupling**

Sold In Bags of 20

Sizes: 1/4"(25), 3/8"(38), and 1/2"(50)  
 Box Qty: 100 (5 bags of 20)  
 Compatibility: 1/4", 3/8" & 1/2" ATR  
 Example pt/n: TA50C-GLV

TA##C-GLV

TA##C-S6



**Channel Nut**

Sold In Bags of 20

Sizes: 1/4"(25), 3/8"(38), and 1/2"(50)  
 Box Qty: 100 (5 bags of 20)  
 Compatibility: 1 5/8", 7/8" Strut  
 Example pt/n: TA25NC-GLV

TA##NC-GLV

TA##NC-S6

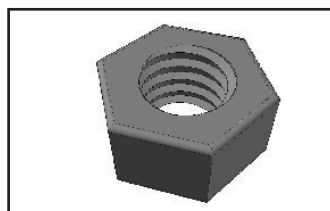

**Hex Nut**

Sold In Bags of 20

Sizes: 1/4"(25), 3/8"(38), and 1/2"(50)  
 Box Qty: 100 (5 bags of 20)  
 Compatibility: 1/4", 3/8" & 1/2" HHCS  
 Example pt/n: TA38NHX-GLV

TA##NHX-GLV

TA##NHX-S6

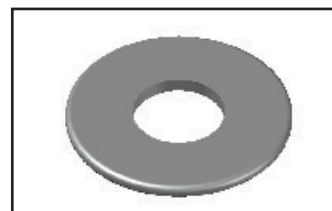

**Flat Washer**

Sold In Bags of 20

Sizes: 1/4"(25), 3/8"(38), and 1/2"(50)  
 Box Qty: 100 (5 bags of 20)  
 Compatibility: 1/4", 3/8" & 1/2" HHCS  
 Example pt/n: TA25W-GLV

TA##W-GLV

TA##W-S6

# TOUGHStrut

**TS2158SH**

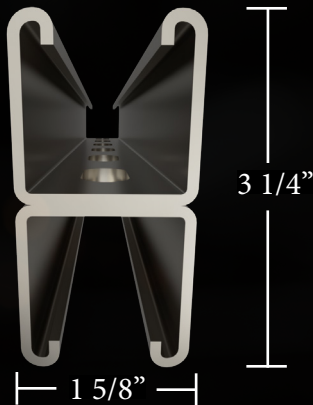

**TS2158S**

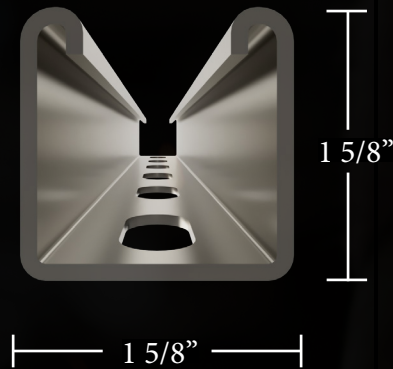

**Height: 1 5/8" X 1 5/8"**

158 TOUGHStrut is an HD metal framing product available in both 12G and 14G material used to fabricate structures that require large loads in electrical and mechanical industries.



28

## TS2158HS-120-GLV

**Product Series**  
TS = TOUGHStrut

**Gauge**  
2 = 12G  
4 = 14G

**Height**  
078 = 13/16"  
158 = 1 5/8"

**Style**  
Blank =   
H = 

**Type**  
Blank = Solid  
S = Slotted

**Length**  
120 = 10'

**Finish**  
PLN  
GLV  
SS6

Example: TS2158-120-GLV

**TS2078HS**

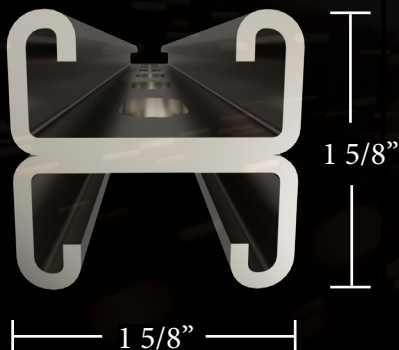

**TS2078S**

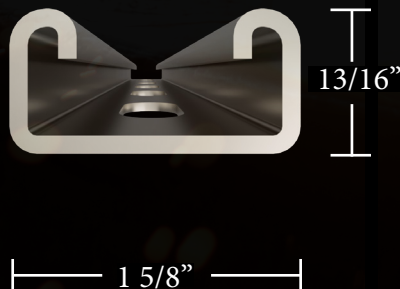

**Height: 13/16" X 1 5/8"**

078 TOUGHStrut is a slimmed down profile offered in both 12G and 14G thick material used to fabricate low clearance structures to support and hang electrical and mechanical systems.

# Engineering

## SUBMITTALS / DATA SHEETS

Do you need product typicals, material compositions, generalized pictorial indices for project submission? CT Innovations has all the technical documentation you need.

## ENGINEERING SERVICES

CT Innovations takes great pride in their ability to provide engineered product solutions. From the initial design concept and planning to final site installation, our engineering team has you and your project covered.

## INSTRUCTION SHEETS

Whether its a straight section, fitting, cover, or one of our many innovative accessories, CT Innovations has detailed instructions to help with installation and project coordination.

## TOUGH SUPPORT SAVINGS

Our products are second to none, but our great products are only half the value CT Innovations brings to the table. With extensive testing and vast knowledge of the codes and standards applied to our products from years of being seated members of the governing bodies, CT Innovations is compiling the GOLD standard of support savings to ensure you maximize your next projects full potential.

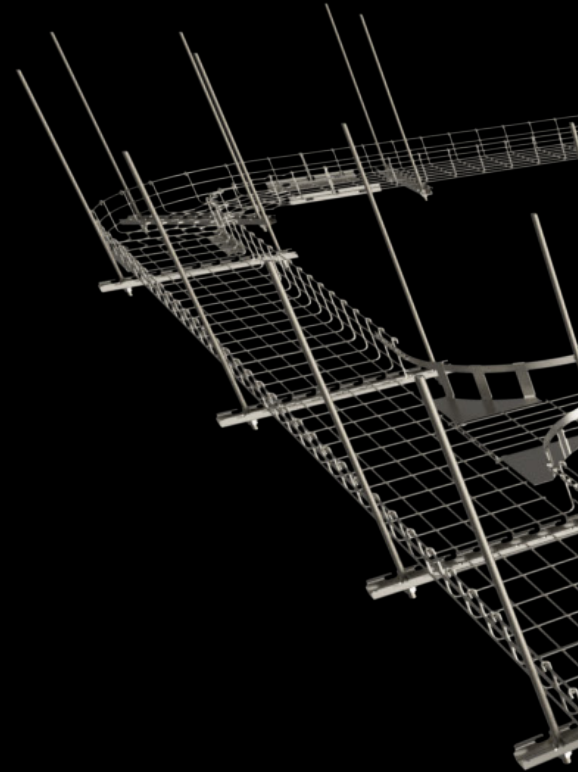



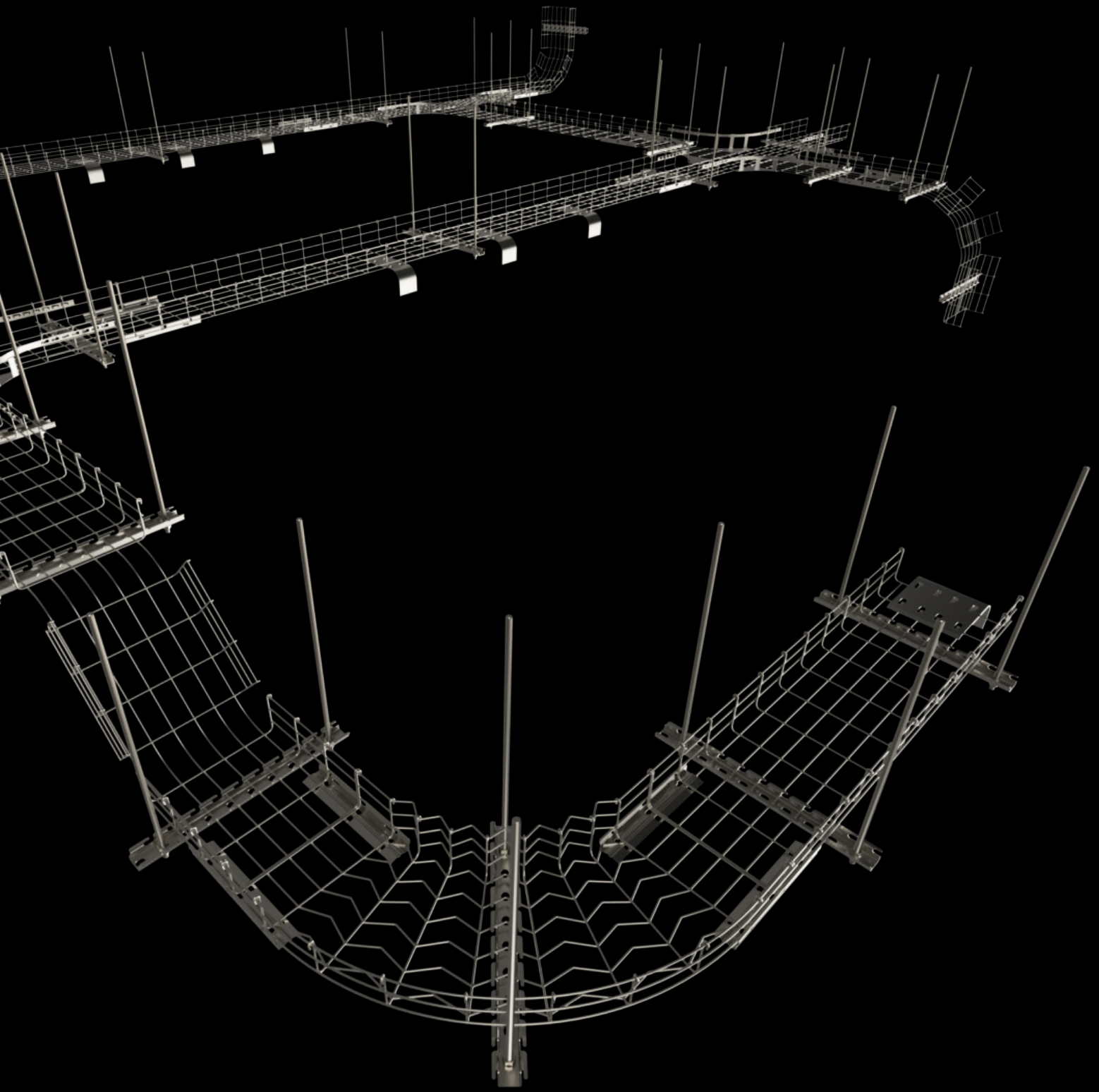

# Finish Recommendations



Recommended



Not Recommended



Indoors



Outdoors



Solar



Industrial



Offshore



Food

	Indoors	Outdoors	Solar	Industrial	Offshore	Food
PL	Not Recommended	Not Recommended	Not Recommended	Not Recommended	Not Recommended	Not Recommended
PG	Recommended	Not Recommended	Not Recommended	Not Recommended	Not Recommended	Not Recommended
PC	Recommended	Not Recommended	Not Recommended	Not Recommended	Not Recommended	Not Recommended
EG	Recommended	Not Recommended	Not Recommended	Not Recommended	Not Recommended	Not Recommended
TG	Recommended	Recommended	Recommended	Recommended	Recommended	Not Recommended
S6	Recommended	Recommended	Recommended	Recommended	Recommended	Recommended

# Project Installations



**INDUSTRIAL - COMMERCIAL - DATACOMM**

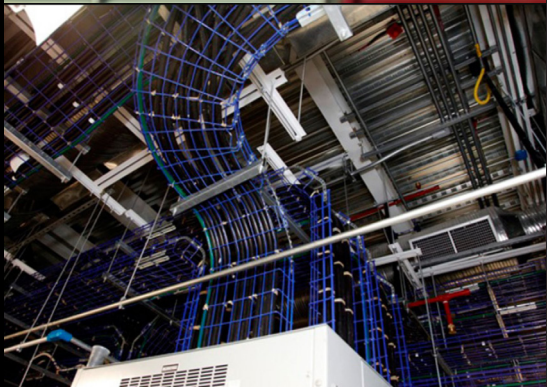



Rev: B

1725 Hughes Landing Blvd, 11th Floor, The Woodlands, TX 77380

**CT INNOVATIONS**

[WWW.TOUGHINNOVATIONS.COM](http://WWW.TOUGHINNOVATIONS.COM)